

# SHELTER

MODEL: JIT-304620PT

L14xW9.15xH6.1 m

Assembly Manual



**Congratulations** on your purchase of our instant shelter. This unit is a combination of excellent manufacturing and design. It is comprised of a rigid frame and a durable cover. For easy assembly, we have marked all the parts with codes, with proper installation, use and maintenance, your unit will provide many years of good and suitable service.

### Tools required

The following hand tool will be needed for proper Installation of your new building:

12mm,14mm, and 17mm Open End Wrenches,

12mm, 14mm, 17mm Sockets or Box Wrench,

Large Flat Head Screwdriver,

2lb maul or Sledgehammer

4 Foot Level 14' Step Ladder

Stake &String for aligning Base Plates &Frame

### Assembly procedure

1. Prepare location and place all unit boxes near location sight. Perform an inventory check before beginning, to be certain all components are available for installation.
2. Secure base plate flanges to base surface.
3. Assemble every group of arch.
4. Begin frame assembly with front end arch, first interior arch, purlins, etc.
5. Add to assemble other groups of arches.
6. Install main cover over frame.
7. Install end cover over end panels.

**Read all the detailed instructions and notices in the following assembly instructions!**

## Maintenance and care

Annually or more often, the unit should be completely inspected internally and externally to make certain the unit remains properly installed and secured. Particular attention should be paid to:

**Hardware**-check all carriage bolts and hardware connectors to be certain they are in place and tightened.

**Weather trends**, the unit will strain against the base plate flange under windy conditions, pegs hardware, connection to frame members should be maintained tight and depth of pegs should be checked to be certain they remain deeply and firmly set.

**Snow Accumulation** -All snow accumulation on the main cover should be removed as soon as possible. Tap the main cover from the inside with a broom or soft brush to clear cover.

**Main Cover Lacing**-the poly rope that secures the main cover to the bottom rail of the frame assembly should be checked, and adjusted as needed. The tension on the main cover should be uniform from end and side to side. Rope ends must be tied off onto the frame members at the ends on each side.

**Cleaning** -cover and doors can be cleaned with a mixture of light detergent and water. A soft bristle brush with the mixture can be used to loosen any hard dirt, mold, or buildup on the cover. After cleansing, the cover should be rinsed thoroughly to avoid any chemical reaction from residual detergent. Allowing dirt and debris to sit on cover over an extended time will damage cover irreparably.

**Severe Weather**-in preparation for inclement weather, completely secure the door of your buildings portable building. Allowing wind to enter end lifts the

**Thanks again for choosing this quality product. The following is the detailed assembly instructions for you starting the assembly.**

## Part List of JIT-304620PT

Part Code	Description	Quantity
1	Top roof tube	8
2	Roof curving tube	12
2A	Roof curving tube in the front and back panel	4
3	Roof curving tube at shoulder height	16
4	Sidewall tube	12
4A	Sidewall tube in the front and back panel	2
4B	Sidewall tube to connect the winch rail	2
5L	Base flange in left corner	2
5R	Base flange in right corner	2
6L	Base flange for the left sidewall	6
6R	Right base flange for the right sidewall	6
7	Base flange for standing legs of the door	4
8	Upper door track	4
9	Lower door track	4
10	Rail of front and back panel (beside the door)	4
10A	Bottom rail for winch of mechanical door (beside the door)	2
11	Roof purlin and horizontal tube	49
12	Cover tensioning tube of front and back cover	4
13	Wind Brace Support	8
13A	Tube clip for wind brace support	16
14	Cover Tensioning tube for roof cover	2sets
15	Door dropping tube	12sets
16	Door dropping tube at the bottom	2sets
17	Stake peg	72
18	Hexagonal bolt M10x75MM for swaged connection	242
18A	Hexagonal bolt M14x30MM for base connection	66
19	Carriage bolt M10x85MM for roof purlin and horizontal tubes connection	64
20	Hexagonal Bolt M10x30MM for the standing leg of end panels and the wind brace support tubes	28
21	Bolt M10x90 for winch	4
22	Plastic cap for tensioning tube	12
23	Steel wire for roof	24
24	Steel wire for sidewall	12
25	Turnbuckle	36
25A	Clip for steel wire	72
26	Roof cover	1
27	Front and back cover	2
27A	Door cover	2
28	Rope for fastening the roof cover, the door cover and the front&back cover	15
29	Blanket	48
30	Band for tie down ratchet	16
31	Door beam	2sets
32	Components for mechanical door	2sets
33	Connection for steel wire and carriage bolt	13
34	"L" connection for steel wire and carriage bolt	25

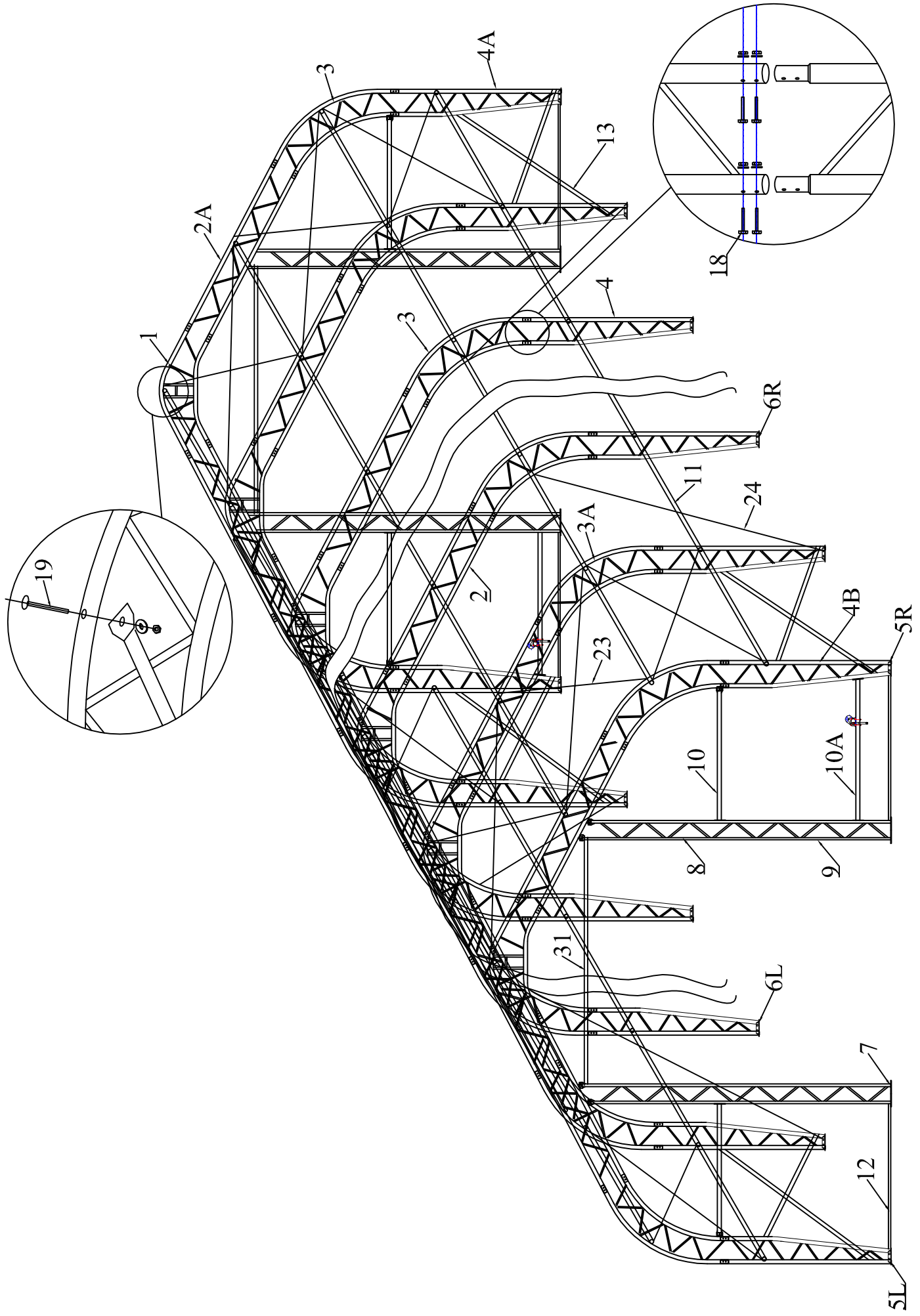

Figure 1 Sketch of Trussed Frame Shelter  
 Size: L14 x W9.15 x H6.1m

### Step #1 --ARCH ASSEMBLY

Assemble ALL the arches including the base plates, and LAY them on the ground first. DO NOT erect them until you finish all the arches assembly.

Each arches consist of:

One Top roof tube (Part # 1), Two Roof curving tube (Part # 2/2A), Two Roof curving tube at shoulder height (Part # 3), Two Sidewall tube (Part # 4/4A/4B), Two Base plates (Part #5L/5R/6L/6R) .

Connect the arches by Using the hexagon bolts with washers and nuts(part #18) through predrilled holes in frame members.

NOTE: Please notice that the part code of the arch sections, The sections of middle, front and back arches are not the same. Check with the Part List and the Sketch Figure.

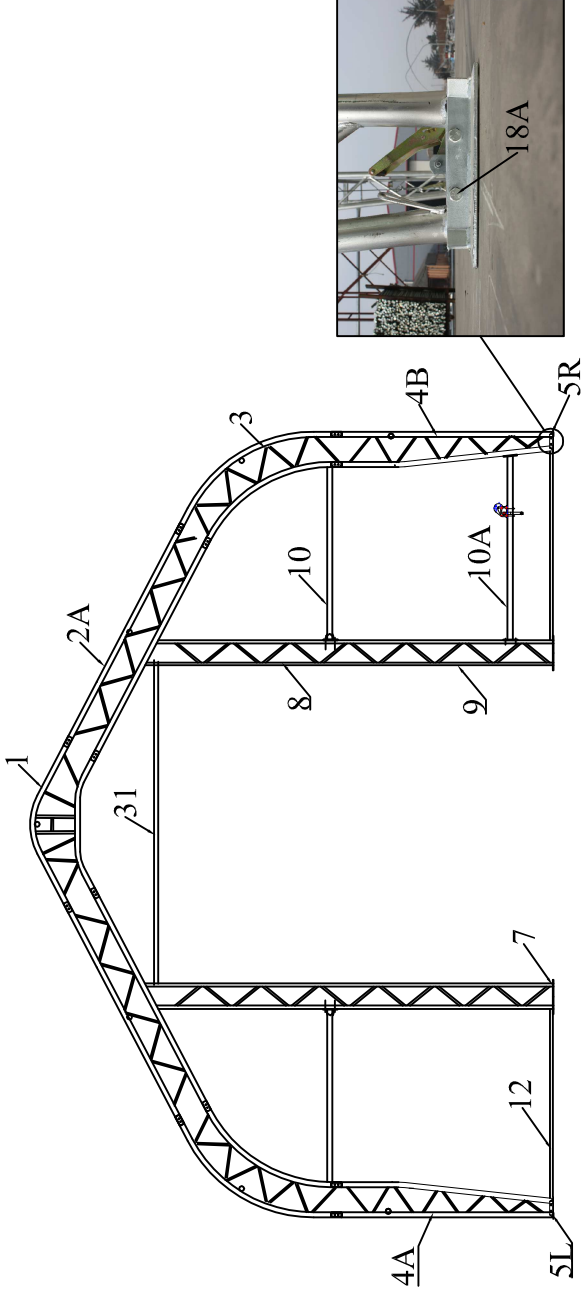

Figure 2 Front Panel Arch

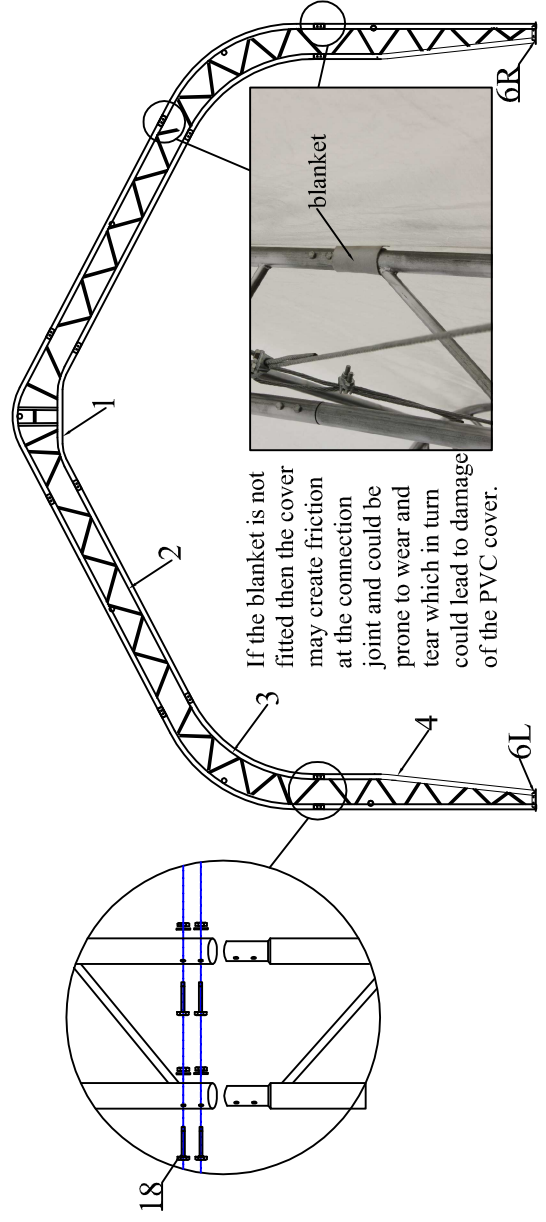

Figure 3 The middle arch

## Step #2 --ERECTING ARCHES

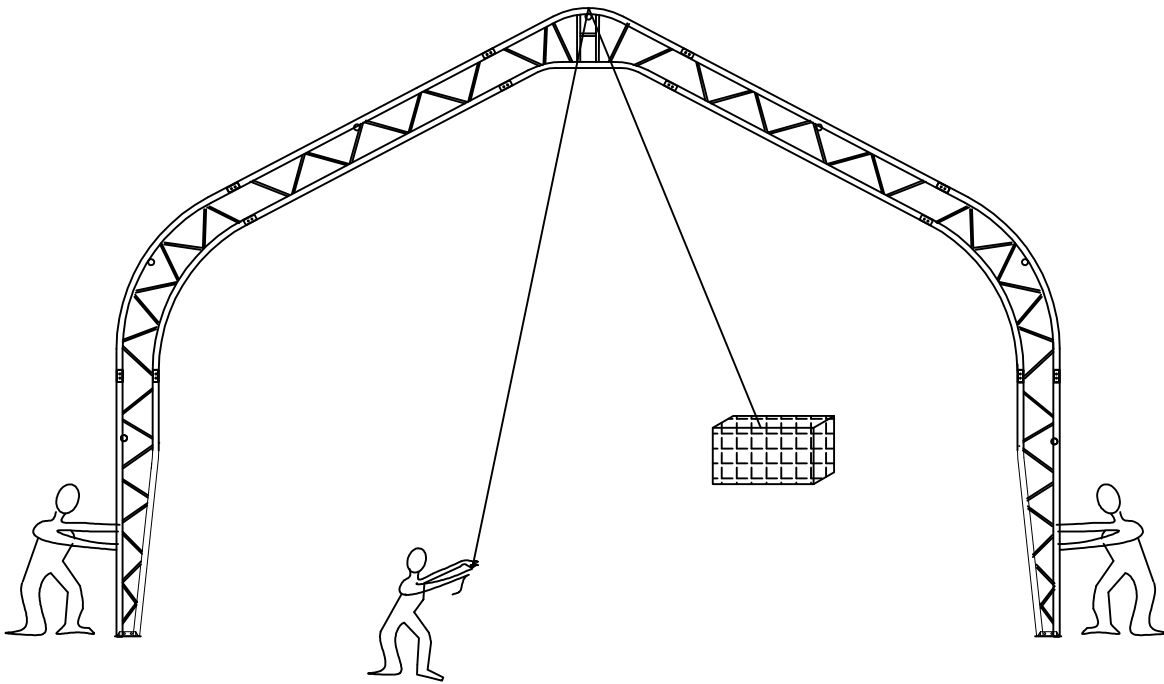

Figure 4 Erecting the Arch

As figure 4 shows, erecting the front arch by using ropes, tie and secure the rope on some heavy object to secure the arch standing temporarily. Then secure the base plates to the ground by using stake pegs(part #17).

## Step #3 --Assembling Roof Purlins

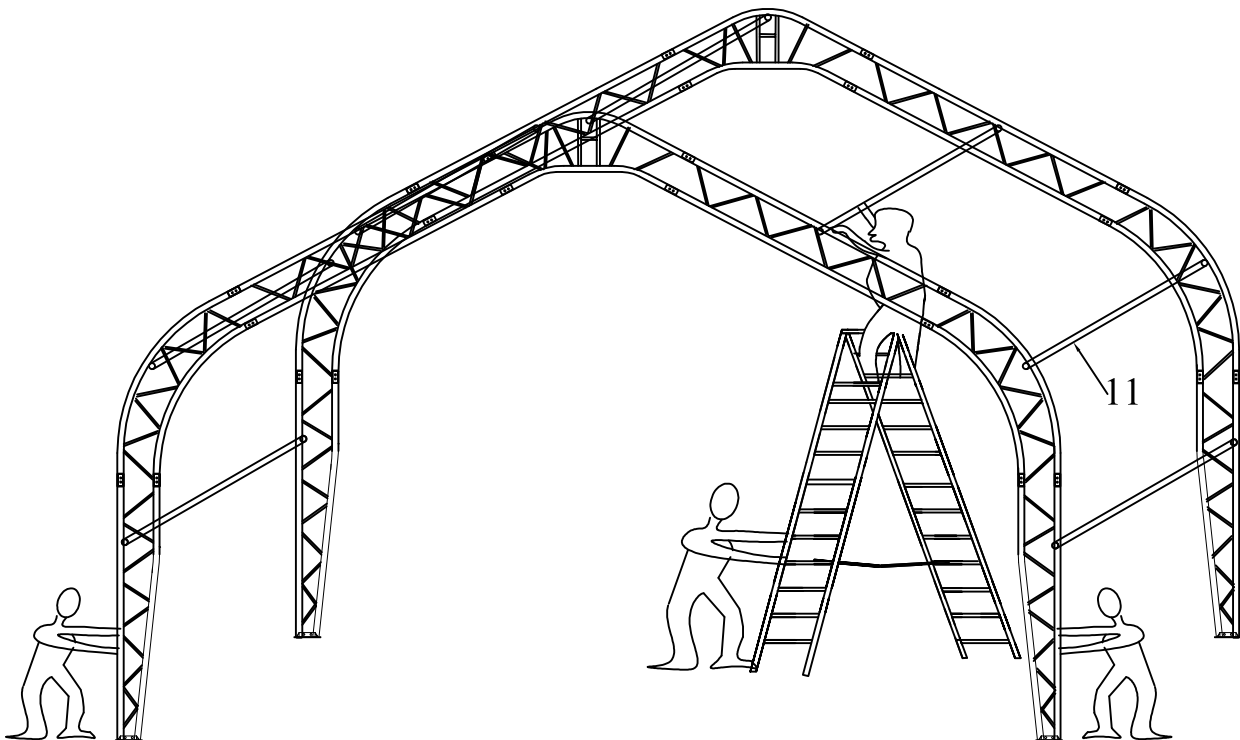
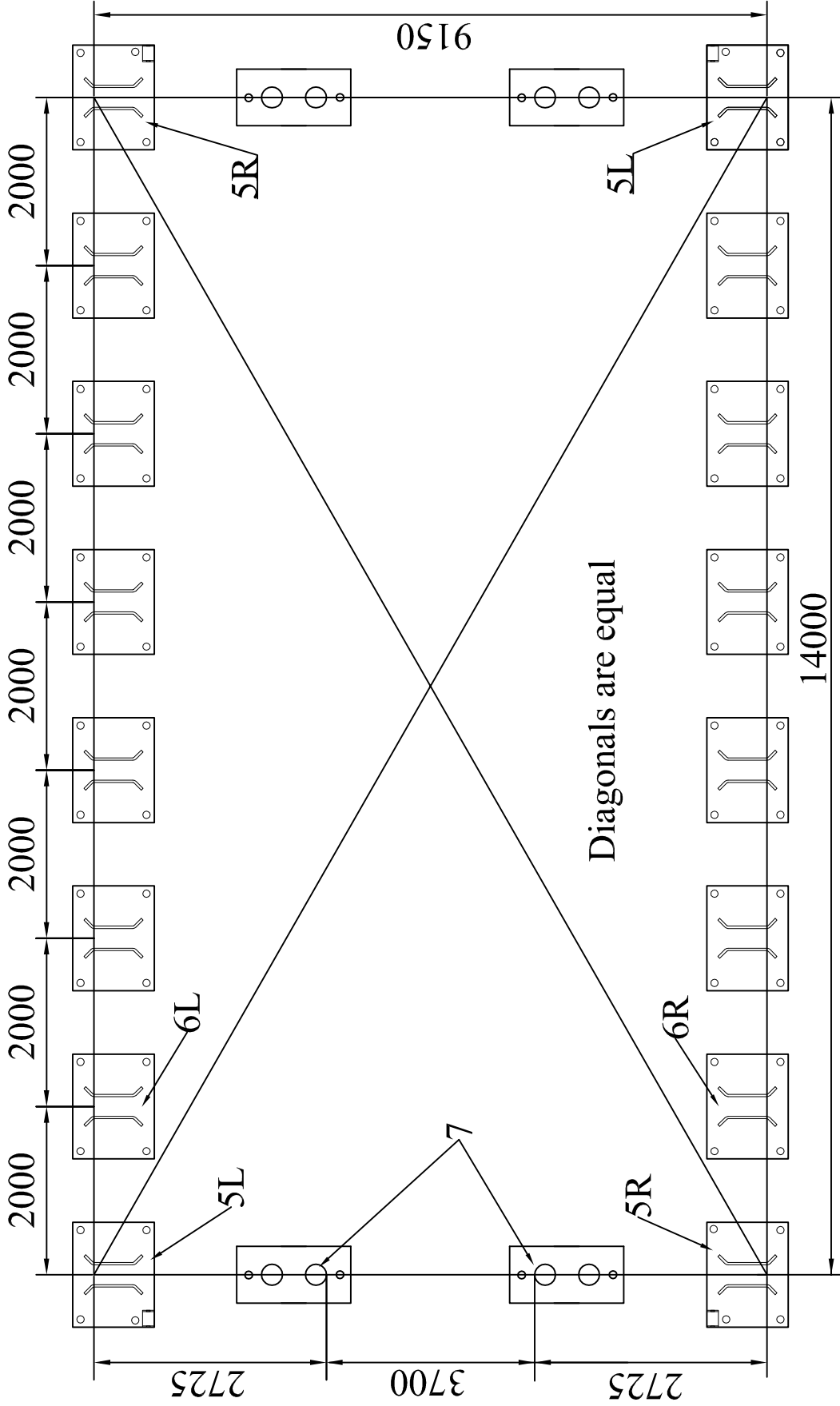

Figure 5

Immediately after erecting the front arch, erect the 2nd arch in the same way. Then connect the two erected arches using Roof Purlin Tubes as figure 5 shows. Secure the Roof Purlin tubes into place using carriage bolts and nuts (part #19).

**Figure 6 Position of Base Flanges**



The Shelter must be secured to a firm surface that can receive and retain pegs firmly in position. The shelter should be installed on FIRM GROUND, not on SWAMP, SOFT/WET GROUND. The Base Flanges must be secured so they cannot be moved.



## Step #4 --WIND STABILIZERS CABLES AND TURNBUCKLES

On each side of frame, between the first and last two groups of arches, and on the front&back panel frame, cables with turnbuckle are provided to align and strengthen frame before installing cover. After installing all cables, tighten the turnbuckles slightly to adjust the arches vertically and to add rigidity.

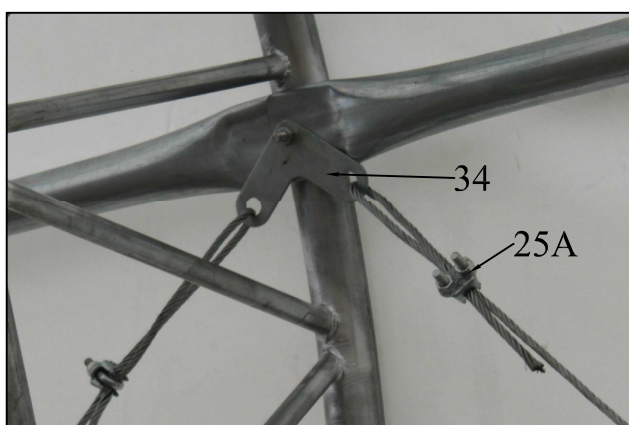
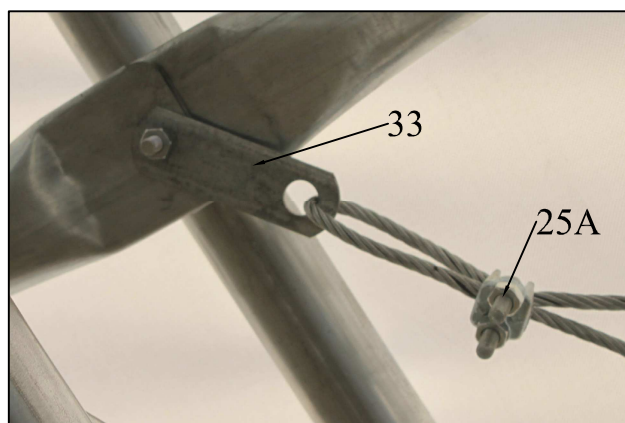
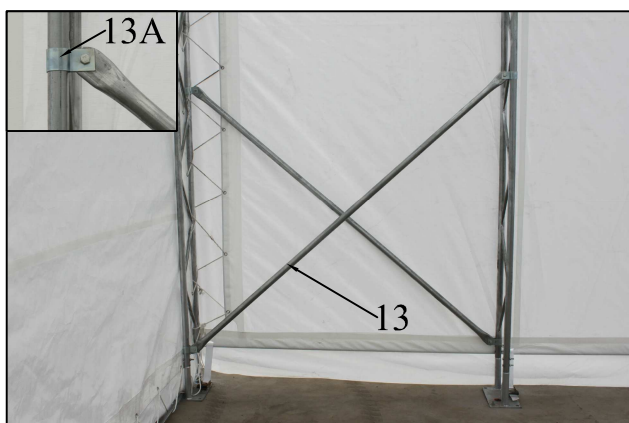
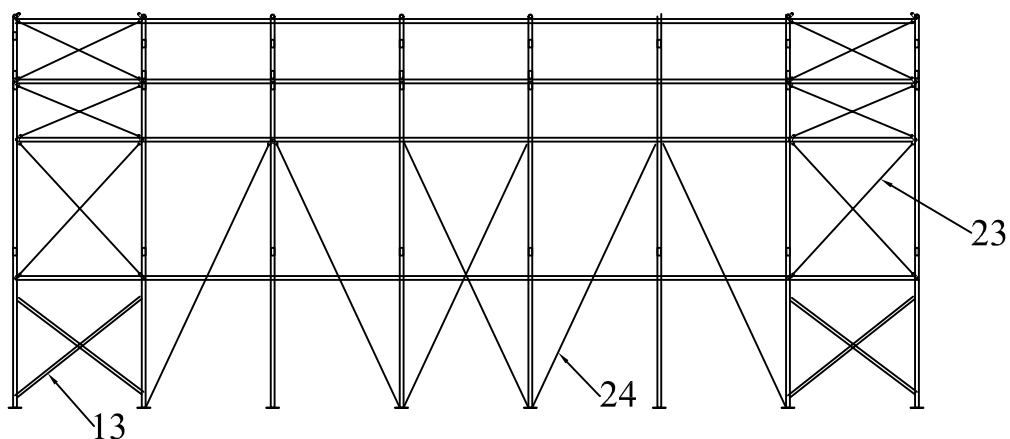

Figure 7 The position of windstabilizers(turnbuckle and cable) at the sidewall.

## ROOF COVER INSTALLATION

### Step #5 --POSITION ROOF COVER

As figure 8 shows, when ready to install Roof Cover, unpack cover and lay parallel to building frame on one side. Cover must be pulled over top of frame assembly without being snagged or stressed on any frame members. Use multiple ropes over top of frame as shown in picture below. Having another person inside frame on a ladder to assist in getting Roof Cover over frame will insure the cover will go on without any damage.

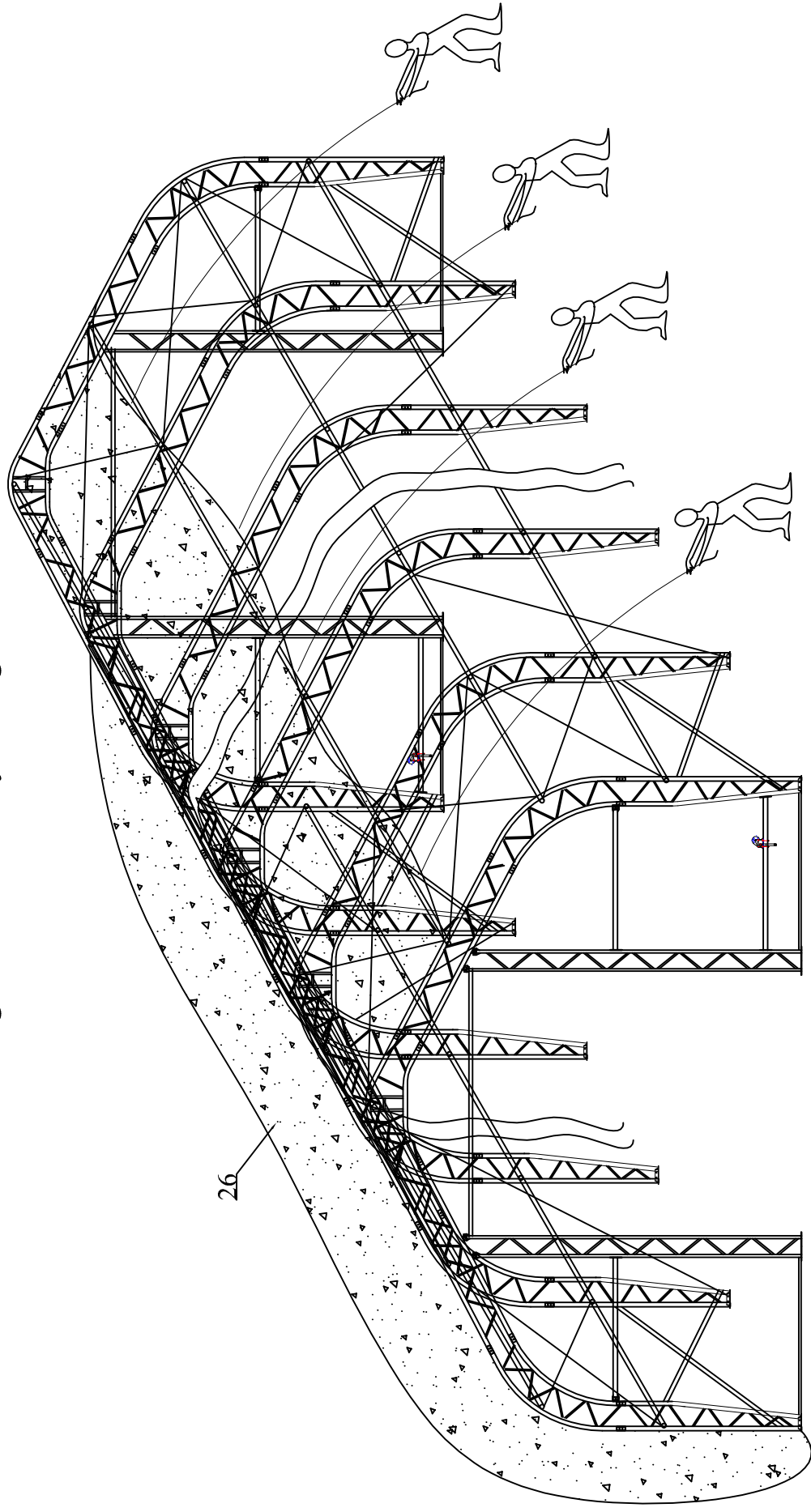

Figure 8 Pull the Roof Cover over the frame evenly

## Step #6 --TENSION COVER ON FRAME FROM SIDE-TO-SIDE

As Figure 9 shows, when Roof Cover is over top of Frame Assembly, insert Cover Tensioning Tubes into pockets along both sides of Roof Cover. Center Roof Cover over Frame assembly both side to side and front to back. Align one side of Roof Cover evenly front to back. Add Band for Tie Down Ratchet at each point along the cover opening, as shown. Put Band for Tie Down Ratchets over Cover Tensioning Tubes at each Base Plate along one side. Bands do not attach to Tensioning Tubes, but loop around and secure at both ends on ratchet.

Next take up slack in tie bands by ratcheting the mechanisms, tightening cover. Evenly adjust ratchets on both sides of roof cover to take wrinkles out of roof cover. **DO NOT** fully tighten cover yet. Leave adequate slack so that cover can also be adjusted front to back in next step.

Then make the cuts using forfex along the outlines.

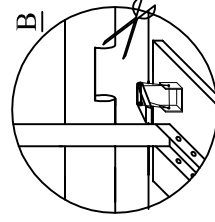

Before inserting the cover tensioning tube(part #14) into pocket of roof cover, you need to make cuts for band of Ratchet on the cover first. Firstly please draw the outline of the cuts according to the position of Ratchet. The position of cuts should be right upon the ratchets.

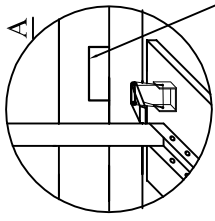

draw the outline of cuts

First circle the band for tie down ratchet (part#30) around the tensioning tube through the cuts on the pocket of the roof cover.

Then put the bands through the reel of the ratchet, and tension the band by ratchet.

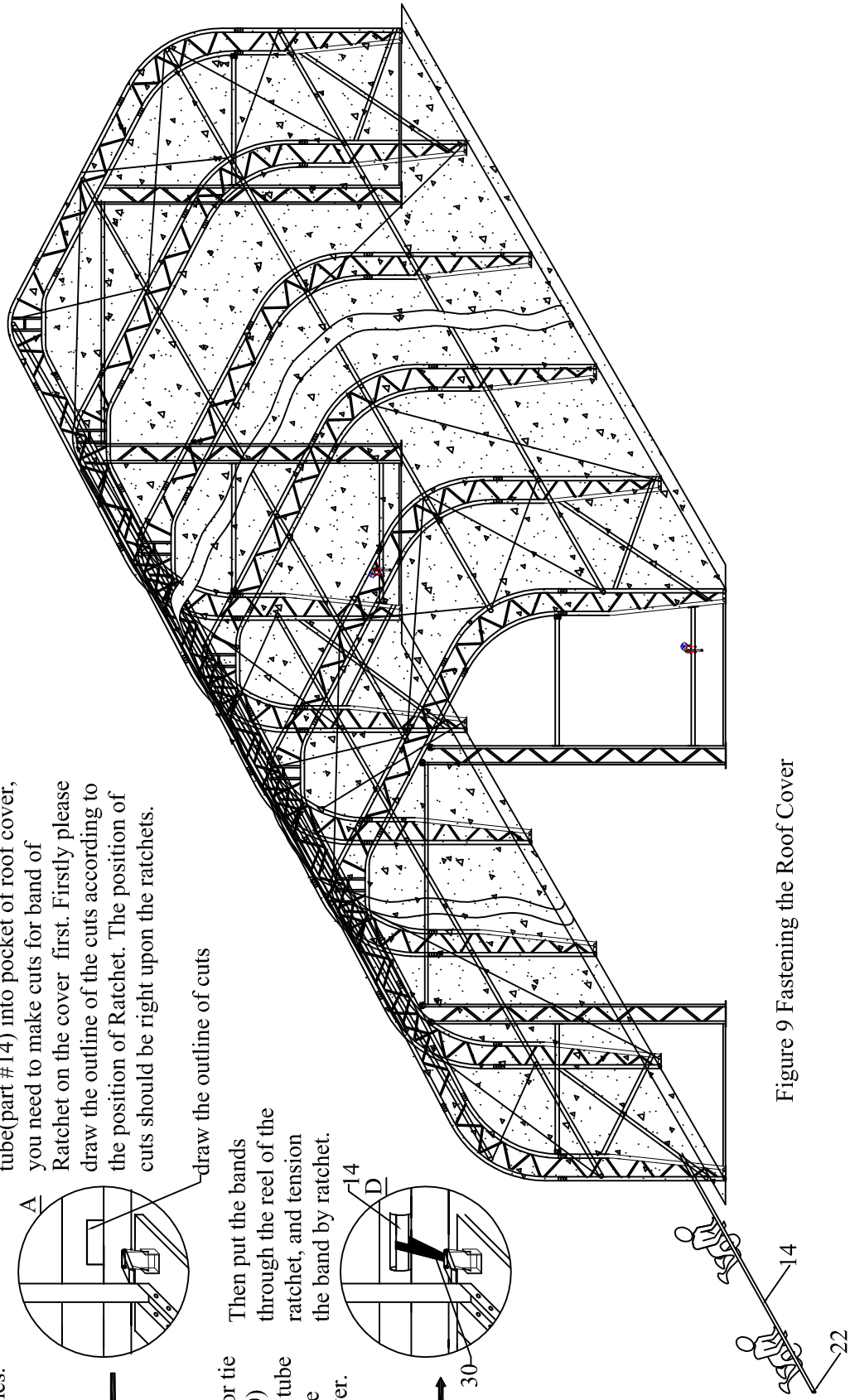
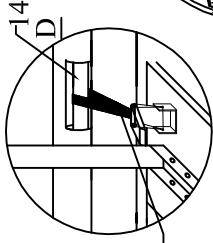
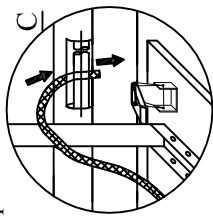

Figure 9 Fastening the Roof Cover

## Step #7 --TIGHTEN ROOF COVER ON FRAME FRONT TO BACK

The roof cover is tensioned from front to back by the rope lacing to grommet flaps inside the main cover, inside the unit at both front and rear arches. Using the rope provided, lace the main cover grommet flap around the main frame front and rear arch pieces. Start in the top middle of each arch, and lace to each side. Add rope length by tying pieces together or cutting as necessary.

Lace all grommets on cover inside flap with rope. Starting at the middle top point over the door, tighten lacing only enough to take wrinkles out of the cover. Repeat for the Rear Arch. **DO NOT** over tighten lacing to pull out the grommets.

After the roof cover lacing is adjusted evenly across the grommet flap, go back and re-adjust the Tensioning Ratchets along the side edges of the Roof Cover. At this point, the main cover can be pulled taut enough to take all excess material and wrinkles out of cover. It will be necessary to repeat this step 2-3 weeks after unit assembly is complete and roof cover has a chance to stretch out over the frame completely.

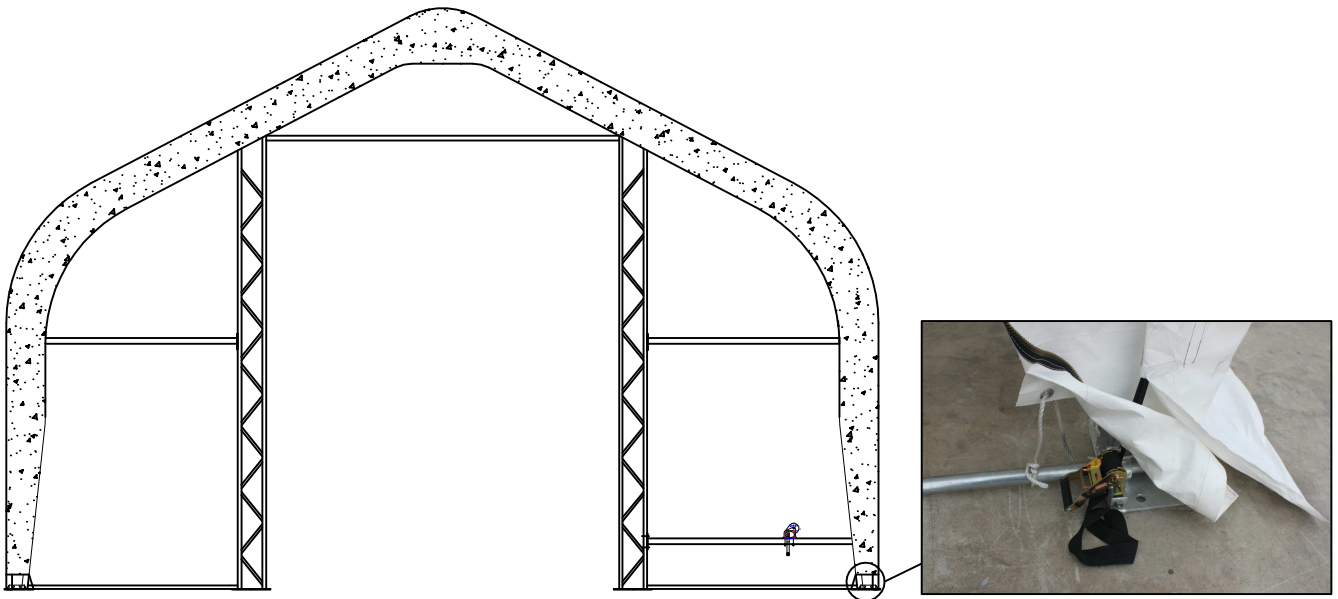

Figure 10 Fastening the two ends of the Roof Cover

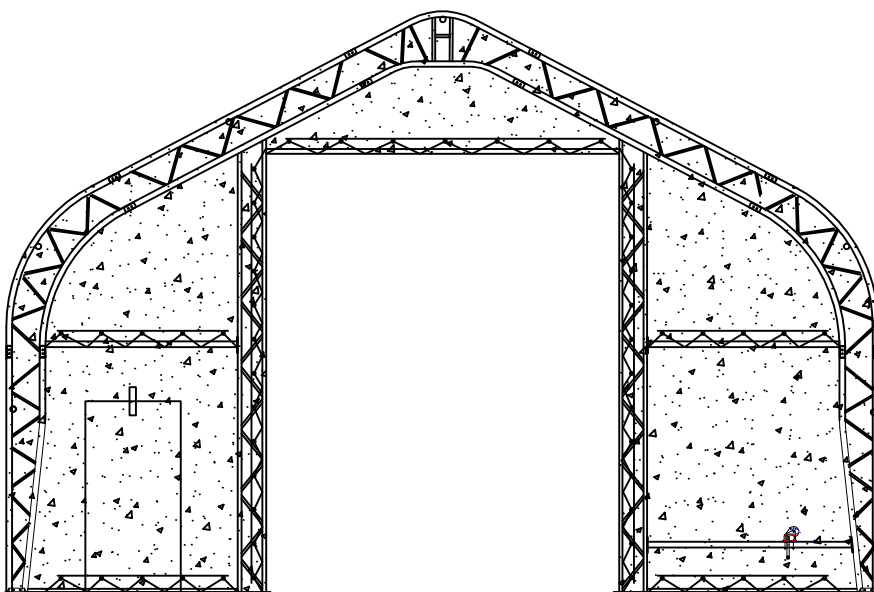

Figure 11 Installation of Front and Back Panel Cover

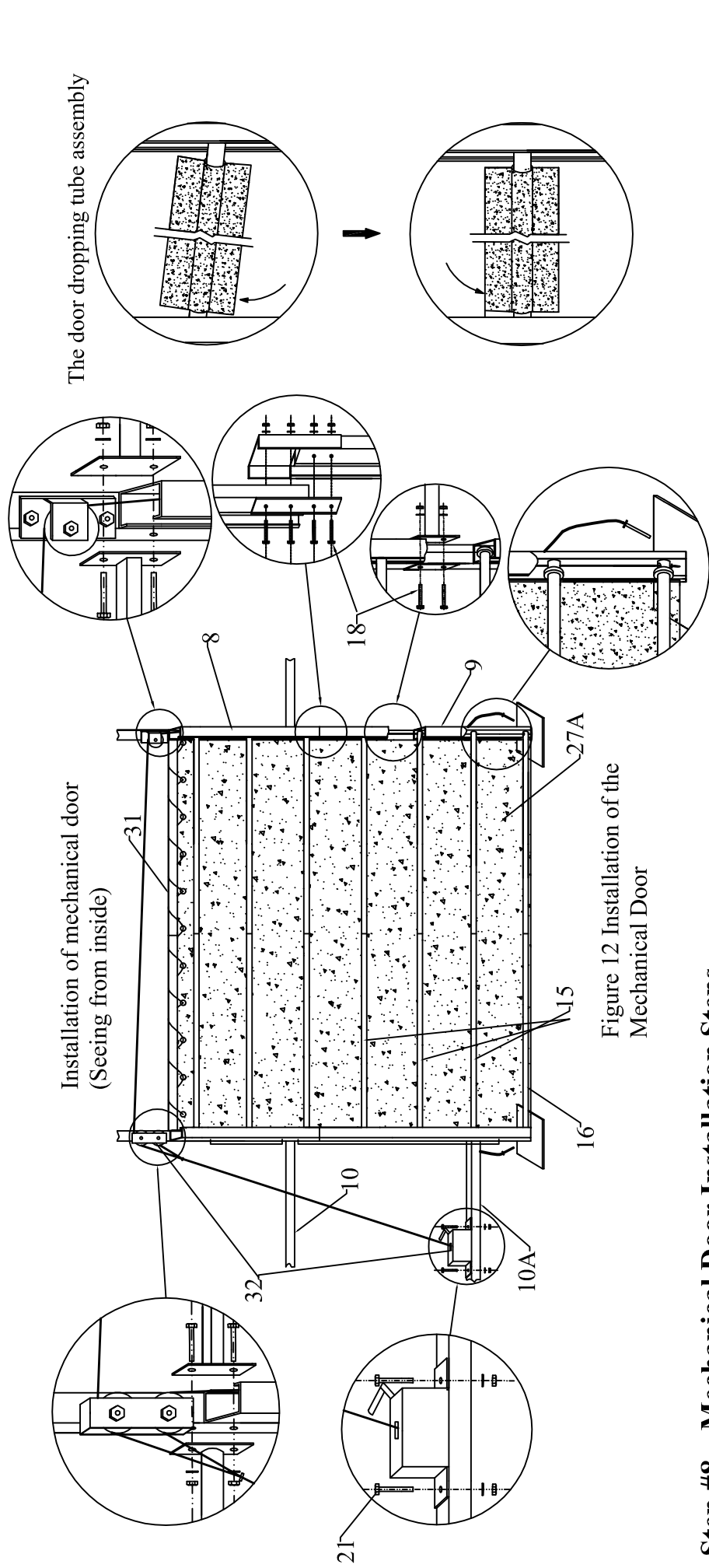

Figure 12 Installation of the Mechanical Door

### Step #8 --Mechanical Door Installation Steps

1. Install Main Door Pulleys (left and right) over the Top of the Door on each side of the Door Beam (Part #31).
2. Next mount the Winch Mechanism to the Front Panel Lower Beam (Part #10A).
3. Slide Bottom Door Dropping Tube (Part #16) into the bottom horizontal fabric pocket on the Door Cover(Part #27A). Then slide the six remaining Door Dropping Tubes (Part #15) into the remaining horizontal fabric pockets in the Door Cover.
4. From the bottom of the door tracks(8,9), gently raise and slide one door dropping tube(15) into the tracks. And then feed the other remaining door dropping tubes(15,16) into the door tracks.
5. Next install the steel wire that leads from the door winching assembly to the bottom of the door dropping tubes. The Winch Assembly has a long and a short steel cable secured to it. Feed the end of the shorter of the two cables through the lower roller of the double pulley at the top of the door assembly track closest to the Winch Assembly, and then down through the holes in the Bottom Door Dropping Tube (16) on the left hand side of the door (facing from the inside). When the steel cable goes down through the hole in the Bottom Dropping Tube (16), tie a knot in the steel wire so that it cannot pass back up through the hole.
6. From the Winch Assembly route leading end of the Longer Steel Cable through the Upper Roller of the double pulley on near door track and then through the Single Roller on the door track farthest from the Winch Assembly. Then down through the Bottom Door Dropping Tube (16). When the steel cable goes down through the hole in the Bottom Door Dropping Tube (16), tie a knot in the steel cable. Door can now be opened or closed by operating the Winch Assembly. Raise and lower the door several times to be certain door tube ends are not binding on track. Lubricate if necessary.